



**UNI-T®**

**Model UT181A  
OPERATING MANUAL**

## PREFACE

Dear users,

Thank you for selecting new UNI-T meters. In order to use this meter properly, please read through this manual carefully before you use it especially on the section of "Safety Precautions". If you have finished reading this manual, we recommend that you properly keep this manual for reference in the future use.

## LIMITED WARRANTY AND LIMITED LIABILITY

UNI-T company guarantees that the product will be free from any defects in materials and workmanship from the date of purchase within one year. This warranty does not apply to fuses, disposable batteries, or damage from accident, neglect, misuse, alteration, contamination or abnormal operation or handling. Resellers are not authorized to give any other guarantee in the name of UNI-T. If any warranty service is required during the warranty period, please contact your nearest authorized UNI-T service center to obtain return authorization information; then send the product to that service center with a description of the problem. This warranty is the only compensation that you can get. In addition, UNI-T does not provide any warranty, express or implied, for example, implied warranty applicable for a particular purpose. Meanwhile, UNI-T is not responsible for any special, indirect, incidental or consequential damage or loss as a result of any reason or speculation. Because some regions or countries do not allow limitations on implied warranties and incidental or consequential damages, so the above limitations of liability and provisions may not apply to you.

## Contents

I. Overview-----	28	12. Temperature-----	54
II. Unpacking Inspection-----	28	13. LPF-----	55
III. Rules for Safe Operation-----	29	14. dBV-----	56
IV. Electrical Symbols-----	30	15. dBm-----	56
V. Meter Structure-----	31	16. Maximum Value and Minimum Value-----	56
VI. LCD Display-----	32	17. Relative Value-----	57
VII. Keys, Rotary Switch and Input Terminals-----	33	18. Peak Detection-----	57
VIII. Technical Index-----	35	19. Compare Mode COMP-----	57
1. General Specifications-----	35	20. Recording Measured Data-----	58
2. Electrical Specifications-----	36	21. Communication-----	62
IX. Measurement Operation-----	44	X. Maintenance and Repair-----	62
1. Meter Power Control-----	44	1. General Maintenance and Repair-----	62
2. Meter Settings-----	45	2. Testing Fuss-----	62
3. AC Voltage-----	47	3. Replacing Fuss-----	63
4. DC VoltageV-----	47	4. Battery Charge-----	64
5. AC and DC Current-----	48		
6. Resistance-----	50		
7. Conductance-----	51		
8. Capacitance-----	51		
9. Continuity Test-----	52		
10. Diode-----	52		
11. Frequency/Duty Cycle Measurement/Pulse Width-----	54		

## I. Overview

The Model UT181A is a 60000 counts 4 5/6 digits, handheld auto-range true RMS intelligent Multimeter (hereinafter referred to as “the meter”). The overall circuit is designed with LSI ADC as the core. The full-range overload protection circuit and unique appearance design make it to be a special electrical meter with superior performance. It can be used to measure the parameters such as AC and DC voltage, AC and DC current, resistance, conductance, diode, continuity, capacitance, temperature, frequency and pulse width, and it is provided with the functions of data hold, maximum/minimum/average measurement, comparison measurement, relative measurement, peak detection, trends capture and data record/readback as many as 20,000 pieces.

This Operating Manual covers information on safety and cautions. Please read the relevant information carefully and observe all the Warnings and Notes strictly.

### Warning:

Please read the “Rules for Safe Operation” before using the meter.

## II. Unpacking Inspection

Open the package case and take out the meter. Please check the following items to see any missing or damaged part:

1. One operating manual
2. A pair of test leads
3. Two K type temperature probes
4. One temperature connector
5. One charging adapter
6. One charging connector
7. One USB cable
8. One CD
9. One cloth bag
10. One warranty card

If you find any missing or damage, please contact your supplier immediately.



### III. Rules for Safe Operation

Please note the "Warning Signs and Words." Warnings indicate the conditions and actions which pose hazards to users or may damage the meter or equipment under test.

This Meter is designed to comply with the safety standards, Conforms to UL STD. 61010-1, 61010-2-030, 61010-2-032, 61010-2-033, Certified to CSA STD. C22.2 NO. 61010-1, 61010-2-030, IEC STD 61010-2-032, 61010-2-033 in pollution degree 2, measurement category (CAT III 1000V, CAT IV 600V) and double insulation as well as with the IP65 standards for waterproof and dustproof. If you use the meter without following up the operating instructions, the protection provided by the meter may be impaired or lost.

**Measurement Category III** (CAT III) is for measurements performed in the building installation. Examples are measurements on distribution boards, circuit-breakers, wiring, including cables, bus-bars, junction boxes, switches, socket-outlets in the fixed installation, and equipment for industrial use and some other equipment, for example, stationary motors with permanent connection to the fixed installation.

**Measurement Category IV** (CAT IV) is for measurements performed at the source of the low-voltage installation. Examples are electricity meters and measurements on primary overcurrent protection devices and ripple control units.

1. Never use a damaged meter. Before using the meter, check

- the meter case to see cracks or any missing plastic part. Pay special attention to the insulation around the connectors.
2. Before using the meter, ensure the battery cover is closed and latched. Before opening the battery cover, remove the test leads from the meter.
3. Inspect the test leads for damaged insulation or exposed metal. Check the test leads for continuity. If any test lead is damaged, replace it before using the meter.
4. Do not apply more than the rated voltage, as marked on the meter, between the terminals or between any terminal and grounding.
5. Do not use the meter when removing the cover or opening the case.
6. When the meter works at a voltage 30V (rms) in AC, 42V (peak) in AC or over 60V in DC, special care should be taken for there is danger of electric shock.
7. Replacement fuse must comply with the specifications in this Operating Manual.
8. Use proper terminals, function and range for your measurement. Do not operate the meter separately.
9. When measuring the current, shut off the power to the circuit then connect the meter to the circuit. Remember: The meter and the circuit must be connected in series.
10. When making electrical connections, connect the common test lead before connecting the main test lead; when disconnecting, disconnect the main test lead before disconnecting the common test lead.



11. If the meter works improperly, do not use it. The protection measures of the meter may have failed. If in doubt, send the meter for repair.
12. Do not store or use the meter in an environment of high temperature, humidity, inflammable, explosive and strong magnetic field.
13. When using the probes, keep your fingers behind the finger guards.
14. Do not use the low-pass filter to verify hazardous voltage, for there may be a voltage over the indicated value. First, measure the voltage to check whether it is hazardous in the case of not connecting a filter, then select low-pass filtering.
15. Before testing resistance, continuity, conductance, diode or capacitor, shut off the power to the circuit and discharge all high-voltage capacitors.
16. Before measuring the current, check the fuses of the meter.
17. Do not measure the voltage or current higher than the allowed input values. When the range of measured values cannot be determined, set the functional range switch at the maximum-range position.
18. When the symbol " " shows on the LCD display, the battery should be promptly charged to ensure measurement accuracy.
19. Do not arbitrarily change the wiring within the meter to avoid damaging the meter and endangering the safety.
20. Soft cloth and mild detergent should be used to clean the













surface of the meter when servicing. No abrasive and solvent should be used to prevent the surface of the meter from corrosion, damage and accident.

21. To test the known voltage before use to confirm the product function is correct.
22. If you want to replace the test lead, you need to replace it with a test lead of the same or higher grade of CAT III 1000V/CAT IV 600V.

### **Dangerous Voltage**

When the meter detects the voltage  $\geq 30V$  or overload (OL), the symbol " " will display as a warning for potential hazardous voltage.

## IV. Electrical Symbols

	Double Insulated
	Grounding
	Warning
	AC (Alternating Current)
	DC (Direct Current)
	Continuity Buzzer
	Diode
	Capacitance
	AC or DC (Alternating Current or Direct Current)
	Danger High Voltage
	Conforms to Standards of European Union.
	This symbol signify the product comply with both USA and Canada requirement

## V. Meter Structure (see Figure 1)

1.	Case
2.	LCD
3.	Function Keys
4.	Rotary Switch
5.	Input Terminals

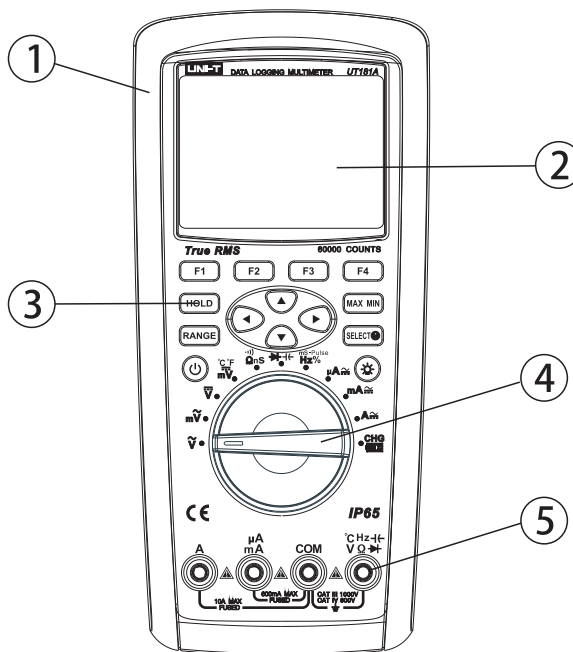

Figure 1

## VI .LCD Display (see Figure 2)

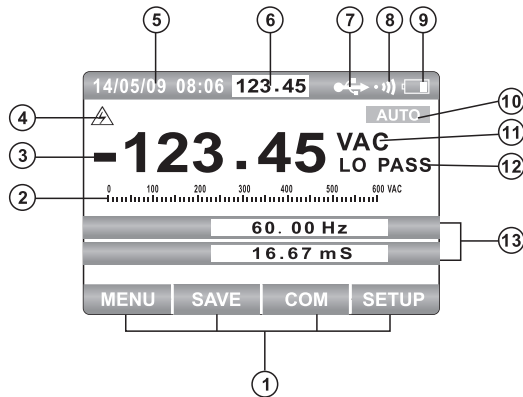

Figure 2





No.	Function	Description
1	Label of Function Keys	Indicates auxiliary functions under current measuring interface
2	Simulation Bar	Analog display of input signals
3	Minus Sign	Indicates minus reading
4	Lightning Symbol	Danger- High Voltage
5	Time and Date	Indicates the time and date set in internal clock
6	Small Measurements	Real-time input values are displayed when the primary and secondary displays are covered by menus or pop-up message.
7	Telecommunication	Indicates the USB/Bluetooth function is enabled.
8	Buzzer	Indicates the button sound is enabled (unrelated to the alarm of continuity test)
9	Battery Capacity	Indicates the capacity level of rechargeable battery
10	Range Indicator	Indicates the current range and range mode for the meter(auto or manual)
11	Unit	Indicates the measurement unit
12	Aided Function Display	Indicates the aided measuring function, such as LPF
13	Aided Display	Indicates the aided measuring information on input signals.

## VII. Keys, Rotary Switch and Input Terminals







### (1) Keys





The 14 keys on the meter are used to activate the selected features of extensible rotary switch, browse menus or control the meter power.

The keys shown in Figure 3 are described in the following table.



Key	Function
	Turn on or turn off the meter power
F1 F2 F3 F4	Select the sub-functions and modes related to the functions of rotary switch.
	Cursor keys are used to select menu items, scroll reading information and input data
HOLD	Keep the current reading on the display
RANGE	Switch the range mode of the meter to manual mode, then take turns to switch between all the available ranges. Long press the button to return to automatic range measurement.
MAX MIN	Starts to record MIN MAX values
SELECT 	Press to select the complex function. Long press to enter Help Menu.
	Press the key to switch the backlight brightness. Long press it to turn off backlight.

### (2) Rotary Switch (see Figure 4)

Knob	Function
	Measurement of AC Voltage
	Measurement of mV in AC and mV in AC+DC
	Measurement of voltage in DC and AC+DC
	Measurement of mV in AC and temperature
	Measurement of resistance, continuity and specific conductance
	Diode test and capacitance measurement

<b>Hz% mS-Pulse</b>	Measurement of frequency, duty cycle and pulse width
<b>μA</b> 	Measurement of μA in AC, DC and AC+DC
<b>mA</b> 	Measurement of mA in AC, DC and AC+DC
<b>A</b> 	Measurement of ampere in AC, DC and AC+DC
<b>CHG</b> 	Battery charge

### (3) Input Terminals

Terminal	Description
<b>A</b>	Input terminals for measuring the current (maximum duration is 30 seconds for 20A overload and suspend for 10 minutes)and frequency from 0A to10. 00A.
<b>mA μA</b>	Input terminals for measuring the current and frequency from 0A to 600mA.
<b>COM</b>	Common terminals for all measurements.
<b>V Ω  °C Hz </b>	Input terminals for measuring voltage, continuity, resistance, diode, conductance, capacitance, frequency, period and duty cycle.

In addition to the above, four terminals are used for charging and temperature measurement through corresponding connectors. "Lead Error!" will show on the display for warning if the probes are inserted improperly.

## VIII. Technical Index

### 1. General Specifications

The maximum voltage between any terminal and ground: 1000 V

The fuse protection of mA or  $\mu$ A input terminals: 0.8A H 1000V Fuse Type 6X32mm

A The fuse protection of A input terminals: 10A H1000V Fuse Type 10X38mm

Max. display: 60000

Range: Auto/Manual

Polarity: Auto

Operating temperature:  $-20^{\circ}\text{C}\sim 50^{\circ}\text{C}$

Storage temperature:  $-30^{\circ}\text{C}\sim 60^{\circ}\text{C}$

Relative humidity:  $\leq 80\%$  ( $0^{\circ}\text{C}\sim 30^{\circ}\text{C}$ ),  $\leq 75\%$  ( $30^{\circ}\text{C}\sim 40^{\circ}\text{C}$ ),  $\leq 45\%$  ( $40^{\circ}\text{C}\sim 50^{\circ}\text{C}$ )

Electromagnetic compatibility: In the RF-field of 1V/m: Overall accuracy= specified accuracy+ 5% of range.

No specified index for the RF-field over 1V/m.

Operating altitude: 0~2000m

Temperature coefficient: 0.1X (specified accuracy)/  $^{\circ}\text{C}$  ( $< 18^{\circ}\text{C}$  or  $> 28^{\circ}\text{C}$ )

Internal battery: Lithium battery of 7.4V 2200mAh

Power adapter: Input of 100V~240V,50/60Hz0.2Amax, Output of DC10V 500mA(short-circuit protection for output) . External diameter of 5.5 mm and internal diameter of 2.5mm.

Low battery: The symbol  shows on the LCD.

Dimension: About (225 X100X 60) mm

Weight: About 608g(including battery)

Safety standards: IEC/EN61010-1, EN61010-2-030, EN 61010-2-033 in pollution degree 2, CAT III 1000V,CAT IV 600V

The standards for waterproof and dustproof: IP65

## 2. Electrical Specifications

Accuracy:  $\pm(\% \text{ Reading} + \text{Digits})$ , one-year calibration period; If the temperature variation of environment reaches  $\pm 5^{\circ}\text{C}$ , the accuracy can be adopted after two hours.

The accuracy can be adopted after two hours when the battery charging is completed.

Ambient temperature:  $23^{\circ}\text{C} \pm 5^{\circ}\text{C}$ ;

Ambient humidity:  $\leq 75\% \text{RH}$ ;

Temperature coefficient:  $0.1 \times (\text{Accuracy}) / ^{\circ}\text{C}$  ( $< 18^{\circ}\text{C}$  or  $> 28^{\circ}\text{C}$ )

### (1) AC Voltage

Range	Resolution	Accuracy Tolerance: $\pm(\% \text{ Reading} + \text{Digits})$			
60mV	0.001mV	45~1kHz	1k~10kHz	10k~20kHz	20k~100kHz
		$\pm(0.6\%+60)$	$\pm(1.2\%+60)$	$\pm(3\%+60)$	$\pm(4\%+60)$
600mV	0.01mV	45~1kHz	1k~10kHz	10k~20kHz	20k~100kHz
		$\pm(0.3\%+30)$	$\pm(1.2\%+40)$	$\pm(3\%+40)$	$\pm(4\%+40)$
6V	0.0001V	45~1kHz	1k~10kHz	10k~20kHz	20k~100kHz
		$\pm(0.3\%+30)$	$\pm(1.2\%+40)$	$\pm(3\%+40)$	$\pm(4\%+40)$
60V	0.001V	45~1kHz	1k~10kHz	10k~20kHz	20k~100kHz
		$\pm(0.3\%+30)$	$\pm(1.2\%+40)$	$\pm(3\%+40)$	$\pm(4\%+40)$
600V	0.01V	45~1kHz	1k~10kHz	10k~20kHz	20k~100kHz
		$\pm(0.3\%+30)$	$\pm(1.2\%+40)$	$\pm(3\%+40)$	Only for reference
1000V	0.1V	45~1kHz	1k~5kHz	5k~10kHz	10k~100kHz
		$\pm(0.6\%+30)$	$\pm(3\%+40)$	$\pm(6\%+40)$	Only for reference

- Input impedance: About 10M $\Omega$
- Overload protection: 1000V
- Display: True virtual value for 10% to 100% of the range.



## (2) DC Voltage

Range	Resolution	Accuracy Tolerance:±(% Reading + Digits)
60mV	0.001mV	±(0.025%+20)
600mV	0.01mV	
6V	0.0001V	±(0.025%+5)
60V	0.001V	
600V	0.01V	±(0.03%+5)
1000V	0.1V	

- Input impedance: About 10MΩ
- Overload protection: 1000V
- Relative mode (REL) is required to compensate bias voltage for 60mV

## (3) AC Voltage + DC Voltage

Range	Resolution	Accuracy Tolerance:±(% Reading + Digits)		
60mV	0.001mV	50~1kHz	1k~10kHz	10k~35kHz
		±(1%+80)	±(3%+40)	±(6%+40)
600mV	0.01mV	50~1kHz	1k~10kHz	10k~35kHz
		±(1%+80)	±(3%+40)	±(6%+40)
6V	0.0001V	50~1kHz	1k~10kHz	10k~35kHz
		±(1%+80)	±(3%+40)	±(6%+40)
60V	0.001V	50~1kHz	1k~10kHz	10k~35kHz
		±(1%+80)	±(3%+40)	±(6%+40)
600V	0.01V	50~1kHz	1k~10kHz	10k~35kHz
		±(1%+80)	Only for reference	Only for reference
1000V	0.1V	50~1kHz	1k~10kHz	10k~35kHz
		±(1.2%+80)	Only for reference	Only for reference

- Input impedance: About 10MΩ
- Overload protection: 1,000V
- Display: True virtual value for 10% to 100% of the range.

#### (4) AC Current

Range	Resolution	Accuracy Tolerance:±(% Reading + Digits)	
600 μA	0.01 μA	45~1kHz	1k~10kHz
		±(0.6%+40)	±(1.2%+40)
6000 μA	0.1 μA	45~1kHz	1k~10kHz
		±(0.6%+20)	±(1.2%+40)
60mA	0.001mA	45~1kHz	1k~10kHz
		±(0.6%+40)	±(1.2%+40)
600mA	0.01mA	45~1kHz	1k~10kHz
		±(0.6%+20)	±(1.2%+40)
10A	0.001A	45~1kHz	1k~10kHz
		±(1%+20)	±(3%+40)

- Display: True virtual value for 10% to 100% of the range.
- Overload protection: μAmA range: 0. 8A H 1000V Fuse Type Φ 6x32 mm  
10 A range: 10A H 1000V Fuse Type Φ10x38mm
- Switch on for 30 seconds and suspend for 10 minutes for 20A. Not specified for over 10A.

## (5) DC Current

Range	Resolution	Accuracy Tolerance:±(% Reading + Digits)
600 $\mu$ A	0.01 $\mu$ A	$\pm(0.08\%+20)$
6000 $\mu$ A	0.1 $\mu$ A	$\pm(0.08\%+10)$
60mA	0.001mA	$\pm(0.08\%+20)$
600mA	0.01mA	$\pm(0.15\%+10)$
10A	0.001A	$\pm(0.5\%+10)$

- Overload protection:  $\mu$ AmA range: 0. 8A H 1000V Fuse Type  $\Phi$  6x32 mm  
10 A range: 10A H 1000V Fuse Type  $\Phi$ 10x38mm
- Switch on for 30 seconds and suspend for 10 minutes for 20A. Not specified for over 10A.

## (6) AC Current + DC Current

Range	Resolution	Accuracy Tolerance:±(% Reading + Digits)	
600 $\mu$ A	0.01 $\mu$ A	50~1kHz	1k~10kHz
		$\pm(0.8\%+40)$	$\pm(2.0\%+40)$
6000 $\mu$ A	0.1 $\mu$ A	50~1kHz	1k~10kHz
		$\pm(0.8\%+20)$	$\pm(2.0\%+40)$
60mA	0.001mA	50~1kHz	1k~10kHz
		$\pm(0.8\%+40)$	$\pm(2.0\%+40)$
600mA	0.01mA	50~1kHz	1k~10kHz
		$\pm(0.8\%+20)$	$\pm(2.0\%+40)$
10A	0.001A	50~1kHz	1k~10kHz
		$\pm(1.2\%+20)$	$\pm(3\%+40)$

- Display: True virtual value for 10% to 100% of the range.
- Overload protection:  $\mu\text{A}$  range: 0. 8A H 1000V Fuse Type  $\Phi$  6x32 mm  
10 A range: 10A H 1000V Fuse Type  $\Phi$ 10x38mm
- Switch on for 30 seconds and suspend for 10 minutes for 20A. Not specified for over 10A.

## (7) Resistance

Range	Resolution	Accuracy Tolerance: $\pm$ (% Reading + Digits)
600 $\Omega$	0.01 $\Omega$	In REL state: $\pm$ (0.05%+10)
6k $\Omega$	0.0001k $\Omega$	$\pm$ (0.05%+2)
60k $\Omega$	0.001k $\Omega$	
600k $\Omega$	0.01k $\Omega$	
6M $\Omega$	0.0001M $\Omega$	$\pm$ (0.3%+10)
60M $\Omega$	0.001M $\Omega$	$\pm$ (2%+10)

- Overload protection: 1,000V
- Humidity for 60 M $\Omega$ : <50%

## (8) Conductance

Range	Resolution	Accuracy Tolerance: $\pm$ (% Reading + Digits)
60nS	0.01nS	$\pm$ (2%+10)

- Overload protection: 1000V
- Humidity: <50%

## (9) Capacitance

Range	Resolution	Accuracy Tolerance:±(% Reading + Digits)
6nF	0.001 nF	±(3%+10)
60nF	0.01nF	±(2.5%+5)
600nF	0.1nF	±(2%+5)
6μF	0.001μF	
60μF	0.01μF	
600μF	0.1μF	
6mF	1μF	±(5%+5)
60mF	10μF	Not specified

- Overload protection: 1000V
- Display digits: 6000

## (10) Temperature

Range	Resolution	Accuracy
-40°C~40°C	0.1°C	±(2.0%+30)
40°C~400°C		±(1.0%+30)
400°C~1000°C		±2.5%
-40°F~104°F	0.2°F	±(2.5%+50)
104°F~752°F		±(1.5%+50)
752°F~1832°F		±2.5%

- Overload protection: 1000V
- Two-channel temperature measurement can be performed via temperature connectors.
- Temperature sensor: Applicable to K type(chromel-silicel) thermocouple. Spare parts are point contact Ktype (chromel-silicel) thermocouple (only applicable to the measurement when temperature is below 230 ° C).

## (11) Frequency

Range	Resolution	Accuracy
60Hz	0.001 Hz	$\pm(0.02\%+8)$
600Hz	0.01 Hz	$\pm(0.01\%+5)$
6kHz	0.0001kHz	
60kHz	0.001kHz	
600kHz	0.01kHz	
6MHz	0.0001MHz	
60MHz	0.001MHz	

- Overload protection: 1000V
- Input amplitude: 10Hz~30MHz:  $600\text{mV} \leq a \leq 30\text{V}_{\text{r.m.}}$ . Greater than 30MHz: Not specified

## (12) Duty Cycle

Range	Resolution	Accuracy Tolerance: $\pm(\% \text{ Reading} + \text{Digits})$
10%~90%(10Hz~2kHz)	0.01%	$\pm(1.2\%+30)$

- Overload protection: 1000V
- When the rise time is less than  $1 \mu\text{s}$ , the signals center on trigger level.

## (13) Pulse Width

Range	Resolution	Accuracy Tolerance: $\pm(\% \text{ Reading} + \text{Digits})$
250mS	0.001mS~0.01mS	$\pm(1.2\%+30)$

- Overload protection: 1000V
- When the rise time is less than  $1 \mu\text{s}$ , the signals center on trigger level.
- The pulse width is greater than  $2 \mu\text{s}$  for 10Hz to 200kHz. The pulse width depends on signal frequency.

## (14) Continuity Test

Range	Resolution	Remark
	0.01Ω	Open circuit voltage is around 3V; when the buzzer selects short circuit for sound warning, the resolution is less than 10Ω. The buzzer continuously sounds, the resolution is greater than 50Ω. The buzzer does not sound. When the buzzer selects open circuit for sound warning, the resolution is greater than 50Ω. The buzzer continuously sounds, the resolution is less than 10Ω. The buzzer does not sound.

- Overload protection: 1000V

## (15) Diode Test

Range	Resolution	Remark
	0.0001V	Open-circuit voltage is around 3V. The forward voltage drop value of the measured PN junction is approximately $\leq 3V$ . When the buzzer activates, it will beep briefly for the normal semiconductor junction; If the semiconductor junction shorts out, it will beep continuously. Silicon PN junction drops between 0.5~0.8V as the normal value.

- Overload protection: 1000V

## IX. Measurement Operation

### 1. Meter Power Control



#### 1) Manually start up and shut down the meter power.

When the meter is off, long press  to start the meter. When the meter is on, long press  to shut it off.

The meter cannot be powered off when charging.

#### 2) Indicators for Battery Capacity

The meter is powered by lithium battery. The indicators for battery capacity are in the upper right corner of display to indicate the relative conditions of battery. Various indicators for battery capacity are described in the following table.

Meaning	Battery Capacity
	Full capacity
	Half capacity
	Empty

When the battery capacity is lower than 3% of full capacity, the meter will automatically shut down.

#### 3) Backlight Control

If the display is not visible in low-light situations,  press to switch the backlight brightness. Long press the key to turn off the backlight and enter power saving mode. When the backlight is off, the green light flashes to indicate that the meter is still collecting data. Press any key or turn the rotary switch to turn on the backlight again.

#### 4) Auto Power-off



If there is no turning of rotary switch or key action within the time set in the menu item "POWE OFF" under the meter setting "AUTO POWER SAVE", the meter will automatically shut down. Long press  to restart the meter. When the item "POWE OFF" is set as OFF, Auto power-off will be completely prohibited.



## 5) Power Saving Mode

Set the control time of automatic reduction for backlight brightness and off time for display via the meter menu bar "AUTO POWER SAVE" to enter power-saving mode. Please refer to the detailed description about the meter settings.

## 2. Meter settings

Press the function key SETUP (Menu) to set and view the relevant information on the meter. Press the cursor keys   to select relevant menu items of the meter as follows.



### 1) Keypad Tone

Set as ON to enable key sound and OFF to disable key sound, meanwhile the buzzer symbol  in the upper right corner will appear or disappear for its ON and OFF.





### 2) Lead Alarm Buzzer

Set as ON to enable the alarm sound for wrong insertion by probe and OFF to disable the alarm sound for mis-inserted probe.





### 3) Communication

Set as ON to enable USB or Bluetooth communication while a symbol  will appear in the upper left corner. Set as OFF to disable USB or bluetooth communication while the symbol  in the upper left corner will disappear.

### 4) Date & Time

Press the function key SET (Menu) to set the date and time within the meter. Press  or  to select the required edit position, and press  or  to enter different numbers, then press the function key OK (Menu) to confirm. To cancel the settings, press the function key CANCEL (Menu).



### 5) AUTO POWER SAVE

Press the function key SET (Menu) to set the control time of automatic reduction for backlight brightness, off time of display and auto power-off time. Press  or  to move the cursors to select different items. Press  or  to enter the time for power saving mode of this item with minute unit.



Menu Item	Description	Set Value
Brightness Down	Control time of automatic reduction for backlight brightness	ON: 1-60 Min OFF: This function is disabled
Display Off	Off time of display	ON: 1-60 Min OFF: This function is disabled
Power Off	Auto power-off time	ON: 1-60 Min OFF: This function is disabled

Press the function key OK (Menu) to confirm the above settings. To cancel the settings, press the function key CANCEL (Menu)

## 6) More Settings

Press the function key ENTER (Menu) to set the languages of help information, format memory, reset the meter settings, check product model, serial number and available memory space. Press the cursor keys   to select the relevant menu items of the meter as follows.

### ● Help Menu Language

Press the function key SET (Menu) to set the language for help information. Press  or  to select a different language. Then press the function key OK (Menu) to confirm.

To cancel the settings, press the function key CANCEL (Menu).

### ● Memory Format

Press the function key FORMAT (Menu) to enter memory format, then press the function key YES (Menu) to confirm.

To cancel the format, press the function key NO (Menu).

### ● Reset All Setting

Press the function key RESET (Menu) to reset the menu with default settings, then press the function key YES (Menu) to confirm. To cancel the reset, press the function key NO (Menu).

### ● About

Press the function key ABOUT (Menu) to check product model, serial number and available memory space.

### 3. AC Voltage

- 1) Insert the red test lead into the V terminal and the black test lead into the COM terminal.
- 2) Set the rotary switch to  $\tilde{V}$  or  $m\tilde{V}$  as shown in Figure 5. Connect the test leads to the power or load under test in parallel.
- 3) Directly read the measured voltage values on the display. True virtual values are displayed for AC measurement.
- 4) Press the function key MENU (Menu) to enter one menu item in which basic AC voltage measurement can be modified. Press the cursor keys  $\leftarrow$   $\rightarrow$  to select menu items. The red cursor key indicates the selected item, then press F1 to enter the corresponding measuring mode, press F2 to enter relative value measurement, press F3 to set dbm resistance, and press F4 to close the window of additional function.

#### ⚠ Attention:

- Do not input a voltage higher than 1000V. Higher voltage may be measured but it poses risk to damage the meter.
- When measuring high voltage, special care should be taken to avoid electric shock.
- After completing all the measuring operations, disconnect the connection between the test leads and the circuit under test.
- The response mode of AC coupled true RMS is adopted for the conversion of AC with sinusoidal input calibration. The accuracy of non-sinusoidal wave must be adjusted based on the following:

For crest of 1.4~2.0, the accuracy shall be added 1.0%.  
 For crest of 2.0~2.5, the accuracy shall be added 2.5%.  
 For crest of 2.5~3.0, the accuracy shall be added 4.0%.

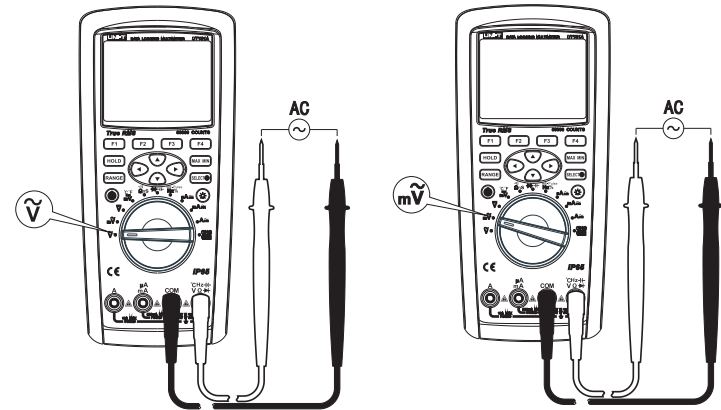

Figure 5

### 4. DC Voltage

- 1) Insert the red test lead into the V terminal and the black test lead into the COM terminal.
- 2) Set the rotary switch to DC V or DC mV as shown in Figure 6. Connect the test leads to the power or load under test in parallel.
- 3) Directly read the measured voltage values on the display.

- 4) Press the function key MENU (Menu) to enter one menu item in which basic DC voltage measurement can be modified. Press the cursor keys  $\leftarrow \rightarrow$  to select menu items. The red cursor key indicates the selected item, then press F1 to enter the corresponding measuring mode, press F2 to enter relative value measurement, and press F4 to close the window of additional function.

**⚠ Attention:**

- Do not input a voltage higher than 1000V. Higher voltage may be measured but it poses risk to damage the meter.
- When measuring high voltage, special care should be taken to avoid electric shock.
- After completing all the measuring operations, disconnect the connection between the test leads and the circuit under test.

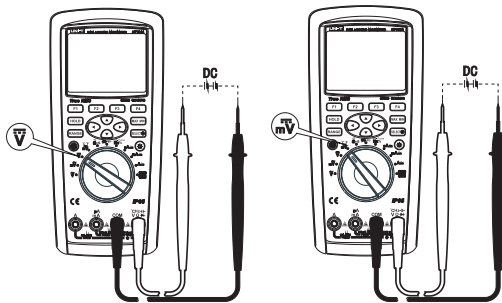

Figure 6

## 5. AC and DC Current

- 1) Insert the red test lead into the  $\mu$ A mA or A terminal and the black test lead into the COM terminal.
- 2) Set the rotary switch to the position as shown in Figure 7. Press the key SEECT to select the required AC or DC to be measured. Connect the test leads to the test circuit in series.
- 3) Directly read the measured current values on the display. True virtual values are displayed for AC measurement.
- 4) Press the function key MENU (Menu) to enter one menu item in which basic AC or DC current measurement can be modified. Press the cursor keys  $\leftarrow \rightarrow$  to select menu items. The red cursor key indicates the selected item, then press F1 to enter the corresponding measuring mode, press F2 to enter relative value measurement, and press F4 to close the window of additional function.

**⚠ Warning**

- Before connecting to the test circuit in series, turn off the power to the circuit first and discharge all the high-voltage capacitors.
- Use proper input terminals and functions for measurement. If the current size cannot be estimated, the range of large current should be measured first.
- When the test lead is inserted in the input terminal of current, do not connect its test prod to any circuit in parallel, it will blow the fuses within the meter and damage the meter.

- After completing all the measuring operations, disconnect the connection between the test leads and the circuit under test.

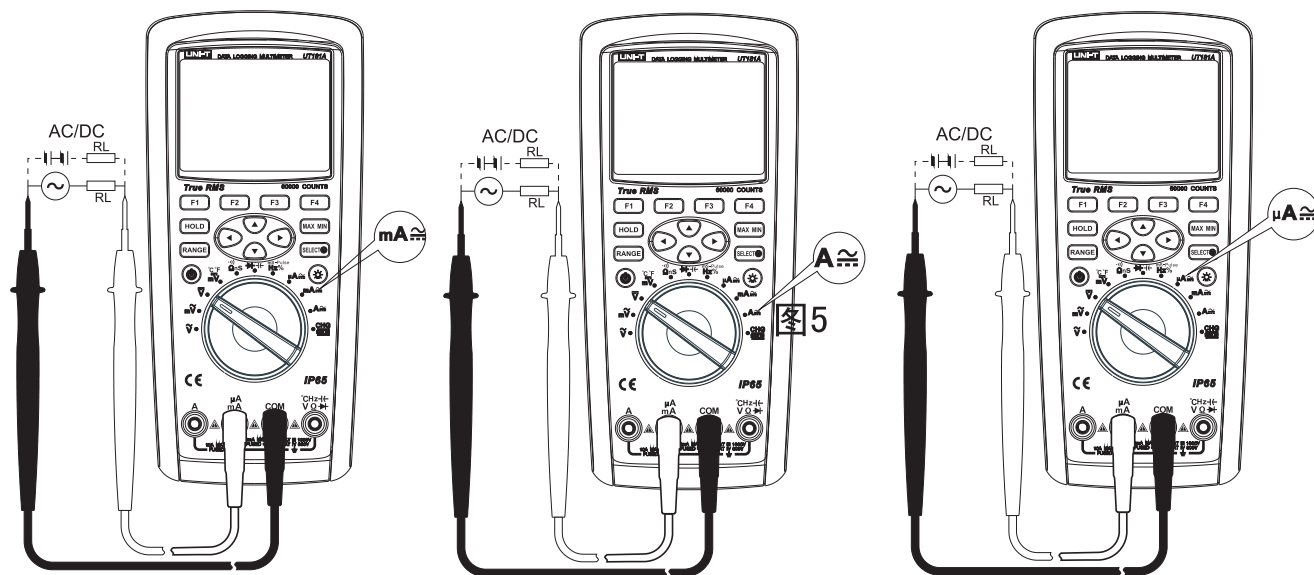

Figure 7

## 6. Resistance

- 1) Insert the red test lead into the  $\Omega$  terminal and the black test lead into the COM terminal.
- 2) Set the rotary switch to the measurement  $\Omega$  nS  $\rightarrow$ ), and current  $\Omega$  is the default resistance measurement as shown in Figure 8. Connect the test leads to both ends of the measured resistance.
- 3) Directly read the measured resistance values on the display.

### ⚠ Attention:

- If the open circuit of measured resistance or resistance value exceeds the maximum range of the meter, "OL" will show on the display.
- When measuring the in-circuit resistance, all the power within the measured circuit must be shut off before measurement and all the capacitors must be discharged to ensure a correct measurement.
- When measuring low resistance, the test lead will bring about measurement errors of resistance between 0.10 to 0.20. To obtain accurate readings, relative measurement can be adopted. First short the input test lead, then press the key MENU and press F2 to enter the relative measurement. Perform the measurement of low resistance after the meter automatically subtracts the display value of shorted test lead.
- If the resistance value is greater than 0.50 for a shorted test lead, the test lead should be checked to see any loose or other factors.

- When measuring the resistance above  $1M\Omega$ , the readings require a few seconds to be stable. It is normal for the measurement of high resistance. In order to obtain stable readings, short test lines can be used for the measurement.
- Do not input a voltage higher than 30V in AC(rms), AC(peak 42V) or 60V in DC to avoid personal injury.
- After completing all the measuring operations, disconnect the connection between the test leads and the circuit under test.

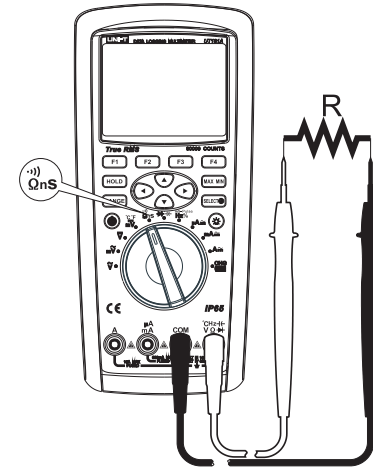

Figure 8

## 7. Conductance

- 1) Insert the red test lead into the  $\Omega$  terminal and the black test lead into the COM terminal.
- 2) Set the rotary switch to the measurement  $\Omega_{ns}$  . press the key SELECT to select conductance measurement 60nS. Connect the test leads to both ends of the measured resistance as shown in Figure 8.
- 3) Directly read the measured conductance value on the display.

### ⚠ Attention:

- When measuring the in-circuit resistance, all the power within the measured circuit must be shut off before measurement and all the capacitors must be discharged to ensure a correct measurement.
- Do not input a voltage higher than 30V in AC(rms),AC(peak 42V) or 60V in DC to avoid personal injury.
- After completing all the measuring operations, disconnect the connection between the test leads and the circuit under test.

## 8. Capacitance

- 1) Insert the red test lead into the  $\text{M}\leftarrow$  terminal and the black test lead into the COM terminal.
- 2) Set the rotary switch to the measurement  $\text{M}\leftarrow$  , press the key SELECT to select capacitance measurement. Connect the test leads to both ends of the measured capacitance as shown in Figure 9.

- 3) Directly read the measured capacitance value on the display.

### ⚠ Attention:

- If the measured capacitance shorts or capacitance value exceeds the maximum range of the meter, "OL" will show on the display.
- For the measurement of capacitance within small range, relative measurement REL should be adopted to avoid the influence of distributed capacitance for correct readings.
- For the measurement of capacitance greater than  $600 \mu F$ , it needs longer time for correct readings.
- To ensure the measuring accuracy, the capacitor should be discharged completely then put into the meter to measure especially for a capacitor with high voltage thus to avoid damage to the meter and personal injury.
- Do not input a voltage higher than 30V in AC(rms),AC(peak 42V) or 60V in DC to avoid personal injury.
- After completing all the measuring operations, disconnect the connection between the test leads and the capacitor under test.

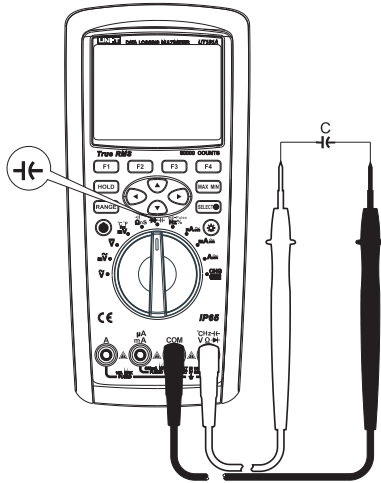

Figure 9

## 9. Continuity test

- 1) Insert the red test lead into the  $\Omega$  terminal and the black test lead into the COM terminal.
- 2) Set the rotary switch to the measurement  $\Omega$  (ns  $\rightarrow$ ), press the key SELECT to select the continuity test  $\rightarrow$ . Connect the test leads to both ends of the measured resistance as shown in Figure 8. Press the function key MENU (Menu) to enter the menu items. If pressing the key SHORT (Menu), then the buzzer selects

short circuit for alarm sound, the measured resistance between both ends  $<10\Omega$ , the buzzer continuously sound  $>50\Omega$ . The buzzer does not sound. If pressing the key OPEN (Menu), then the buzzer selects open circuit for alarm sound, the measured resistance between both ends  $>50\Omega$ , the buzzer continuously sound  $<10\Omega$ . The buzzer does not sound.

- 3) Directly read the measured resistance value on the display.

### ⚠ Warning

- When measuring the in-circuit resistance, all the power within the measured circuit must be shut off before measurement and all the capacitors must be discharged to ensure a correct measurement.
- Do not input a voltage higher than 30V in AC(rms), AC(peak 42V) or 60V in DC to avoid personal injury.
- After completing all the measuring operations, disconnect the connection between the test leads and the circuit under test.

## 10. Diode

- 1) Insert the red test lead into the  $\rightarrow$  terminal and the black test lead into the COM terminal. The polarity of red test lead is "+" and "-" for black test lead.
- 2) Set the rotary switch to the measurement  $\rightarrow$   $\leftarrow$  and the diode measuring mode  $\rightarrow$  is default. Connect the test leads to both ends of the measured diode as shown in Figure 10. Directly read the approximate forward PN junction voltage of the measured diode on the display.



- 3) Press the function key MENU(Menu) to enter menu items. If pressing the key ALARM, the buzzer starts up. It will beep briefly for the normal semiconductor junction; if the semiconductor junction shorts out, it will beep continuously. Silicon PN junction drops between 0.5~0.8V as the normal value. If pressing the key NORMAL, the buzzer will not start up.

**⚠ Attention:**

- If the measured diode is in open circuit or the polarity is reversed, "OL" will display.
- When measuring the in-circuit diode, all the power within the measured circuit must be shut off before measurement and all the capacitors must be discharged.
- Open-circuit voltage of diode test is around 3V.
- Do not input a voltage higher than 30V in AC(rms),AC(peak 42V) or 60V in DC to avoid personal injury.
- After completing all the measuring operations, disconnect the connection between the test leads and the circuit under test.

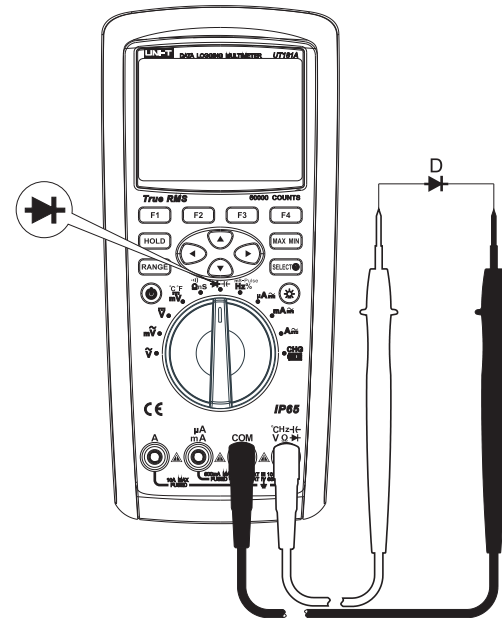

Figure 10

## 11. Frequency/Duty Cycle Measurement /Pulse Width

- 1) Insert the red test lead into the V terminal and the black test lead into the COM terminal.
- 2) Set the rotary switch to the measurement Hz% ms-Pulse, press the key SELECT to select Hz or Duty% or ms-Pulse. Connect the test leads to the signal source under test in parallel as shown in Figure 11.
- 3) Directly read the measured values of frequency or duty cycle or pulse width on the display.

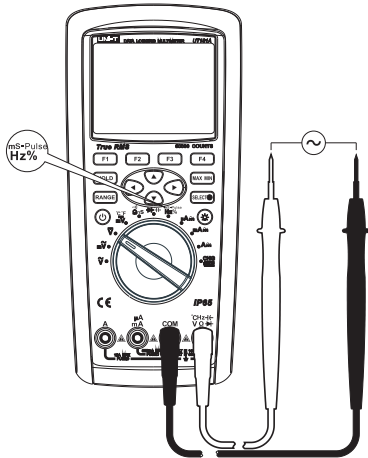

Figure 11

### ⚠ Attention:

- Simulation bar displays the frequency of the measured signal for duty cycle and pulse width.
- Do not input a voltage with higher frequency than 30Vrms to avoid personal injury.
- After completing all the measuring operations, disconnect the connection between the test leads and the circuit under test.

## 12. Temperature

- 1) Set the rotary switch to the measurement " $m\bar{V}^{\circ}C^{\circ}F$ ", then press the key SELECT to select Celsius  $^{\circ}C$  or Fahrenheit  $^{\circ}F$ . Insert the temperature connector into four terminals and connect two temperature probes to the temperature connector. The probes detect the surface of the object under test as shown in Figure 12.
- 2) Directly read Celsius or Fahrenheit temperature values of the two surfaces under test on the display.
- 3) Press the function key MENU (Menu) to open one menu item F2 in which basic temperature measurement can be modified to enter the relative measuring mode. Press F4 to close the window of additional function. Press the cursor keys  $\leftarrow \rightarrow$  to select menu items. The red cursor key indicates the selected item, then press F1 to enter corresponding value measurement. Press F2 to enter relative value measurement, and press F4 to close the window of additional function.

**⚠ Attention:**

- The ambient temperature for the meter shall not exceed the range from 18° C to 28 °C, otherwise it will cause measurement errors. The measurement effects are more obvious at low temperatures.
- Remove the temperature probes after completing all the measuring operations.
- Point contact K type (chromel-silicel) thermocouple (only applicable to the measurement when temperature is below 230 ° C).

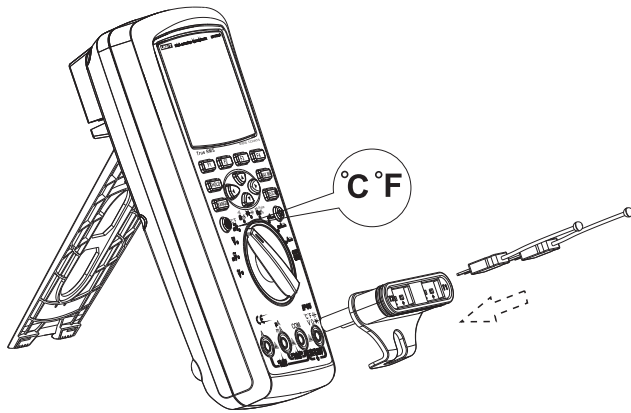
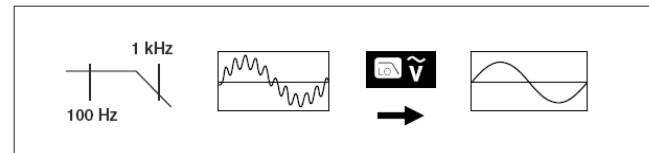

Figure 12

## 13. LPF Measurement

- 1) Insert the red test lead into the V terminal and the black test lead into the COM terminal.
- 2) Set the rotary switch to  $\checkmark$ . Connect the test leads to the power or load to be tested in parallel as shown in Figure 5.
- 3) Press the function key MENU (Menu) to enter one menu item. Press the cursor keys  $\leftarrow$   $\rightarrow$  to select Low Pass, then press the function key (Menu) Low Pass to enter LPF measuring mode.
- 4) The meter performs the measurement in AC mode. The AC signals go through a filter which holds up the voltage higher than 1KHz. As shown in the following figure, the low-pass filter can measure the composite signals of sinusoidal wave generated by inverter and variable-frequency motor.



**⚠ Attention:**

- To avoid electric shock or personal injury, do not use low-pass filter to verify hazardous voltage, for the voltage over the indicated value may exist. First, measure the voltage in the case of disconnecting the filter to see any hazardous voltage. Then select the filter function.

- In the LPF measuring mode, the meter will turn to manual mode. Press the key RANGE to select a range. When the low-pass filter is enabled, the automatic range is unavailable.
- Do not input a voltage above 1000V. Higher voltage may be measured but it poses the risk of damaging the meter.
- After completing all the measuring operations, disconnect the connection between the test leads and the circuit under test.

## 14.dBV

- 1) Insert the red test lead into the V terminal and the black test lead into the COM terminal.
- 2) Set the rotary switch to  $\checkmark$ . Connect the test leads to the power or load to be tested in parallel as shown in Figure 5.
- 3) Press the function key MENU(Menu) to enter one menu item. Press the cursor keys  $\leftarrow \rightarrow$  to select the menu item dBV, then press the function key (Menu) dBV to enter dBV measurement.
- 4) dBV is primarily shown and AC voltage value is secondly shown on the display. AC voltage of the measured signal is displayed on the simulation bar.

## 15.dBm

- 1) Insert the red test lead into the V terminal and the black test lead into the COM terminal.2) Set the rotary switch to  $\checkmark$ . Connect the test leads to the power or load to be tested in parallel as shown in Figure 5.3) Press the function key MENU (Menu) to enter one of the menu items, press the

cursor keys  $\leftarrow \rightarrow$  to select the menu item dBm. A reference impedance (resistance) must be used for the measurement of dBm to calculate dB value on the basis of 1mW. Press the function key RES (Menu) to select a reference impedance value. Press  $\uparrow$  or  $\downarrow$  to scroll between ten defined reference values: 4,8,16,25,32,50,75,600, 1000 and 1200. Press the function key EDIT (Menu) and the cursor keys  $\leftarrow \rightarrow$  to select any one of the reference impedance values between  $4\Omega \sim 1200\Omega$ . Press the function key OK (Menu) to set reference values. Press the function key dBm (Menu) to enter dBm measurement.

- 4) dBm is primarily shown and AC voltage value is secondly shown on the display. AC voltage of the measured signal is displayed on the simulation bar.

## 16. Maximum and Minimum Value

Press MAX MIN to activate the measurement of maximum and minimum values. Real-time measurements are primarily displayed. Maximum, average and minimum values, elapsed time, start date and time corresponding to the three values are secondly displayed. Press the function key RESTART (Menu) to re-activate the measurement of maximum and minimum values. Press the function key EXIT (Menu) to exit the measurement of maximum and minimum values.

## 17. Relative value

Press the function key MENU (Menu) to enter a next interface, press the function key REL (Menu) to enter the measuring mode of relative values, then press the function key REL (Menu) to activate the measurement of relative values, by this time the measurements \_ basic values are primarily displayed and the relative values and real-time measurements are secondly displayed. Press the function key MENU (Menu) to select basic measurement to exit the measurement of relative values.

## 18. Peak detection

Press the function key MENU (Menu) to select Peak item, then press the function key PEAK (Menu) to activate peak detection. Response time is 1ms. Transient values can be more accurately measured by using peak recording function.

## 19 Compare Mode COMP

Press the function key COMP(Menu) to enter the measurement of compare mode. Press  $\odot$  or  $\ominus$  to select the settings of compare mode as follows.

### 1) Pass Mode

Press the function key EDIT(Menu) to enter the setting mode of compare types. Press  $\odot$  or  $\ominus$  to set one of the four types as follows.

- INNER(Low Value  $\leq$  Input Value  $\leq$  High Value)
- OUTER (Input Value < Low Value or Input Value >High Value)

- <Value
- <Value
- >Value
- >Value

Press the function key OK (Menu) to confirm the above settings. To cancel the settings, press the function key CANCEL (Menu).

### 2) Beep Mode

Press the function key EDIT(Menu) to enter buzzer start mode. Press  $\odot$  or  $\ominus$  to select one of the three items as follows.

#### ●PASS ON

It indicates that the buzzer starts to sound when the compare result shows as PASS.

#### ●FAIL ON

It indicates that the buzzer starts to sound when the compare result shows as FAIL.

#### ●OFF

Buzzer close

Press the function key OK (Menu) to confirm the above settings. To cancel the settings, press the function key CANCEL (Menu).

### 3) Low Value or High Value or Value

Press the function key EDIT (Menu) to set compare reference values. Press  $\odot$  or  $\ominus$  to move the cursors to select edit locations. Press  $\odot$  or  $\ominus$  to enter different numbers. Press the function key OK (Menu) to confirm. To cancel the settings, press the function key CANCEL (Menu).

After completing the settings, press the function key START (Menu) to start the measurement of compare mode. Press the function key EXIT (Menu) to exit the measurement of compare mode.

## 20. Recording Measurement Data

Press the function key SAVE(Menu) to enter the modes of single recording, continuous recording and inquire recording. Press the cursor keys  $\leftarrow$   $\rightarrow$  to select the following modes.

### 1) Save

Press the function key SAVE (Menu) to record the current measuring data for once up to 20000 pieces.

### 2) View Save

Press the function key VIEW (Menu) to view one-time recorded data. Press or long press the function key PREV (Menu) to view the previous recorded data. Press or long press the function key NEXT (Menu) to view the next recorded data. Press the function key DELETE (Menu) to delete the current recorded data. Press the function key RETURN (Menu) to return to the last menu. In addition to displaying the recorded data, the location and total number of current recorded data are displayed in the lower left corner. The date and time of current data recording are displayed in the lower right corner.

### 3) Delete All Save

Press the function key DELETE(Menu) to delete all one-time recorded data. Press the function key YES (Menu) to

confirm. To cancel the operation, press the function key NO(Menu).

### 4) Record

Press the function key ENTER (Menu) to enter the continuous recording mode with maximum recording pieces up to 10000. Press  $\leftarrow$  or  $\rightarrow$  and move cursors to select the three settings as follows.

#### ● Edit Name

Press the function key EDIT (Menu) to name the continuous recording items. Press  $\leftarrow$  or  $\rightarrow$  to move the cursor and select edit locations. Press the F1 key to switch the input mode to "Uppercase" mode, then press  $\leftarrow$  or  $\rightarrow$  to input uppercase letters. Press the F2 key to switch the input mode to "Lowercase" mode, then press  $\leftarrow$  or  $\rightarrow$  to input lowercase letters. Press the F3 key to switch the input mode to "Digital" mode, then press  $\leftarrow$  or  $\rightarrow$  to enter numbers or symbols. Press the F4 key to save exit and exit edit mode.

#### ● Set Interval

Press the function key EDIT (Menu) to set the interval time of continuous recording. Press or long press  $\leftarrow$  or  $\rightarrow$  to move the cursors to select edit locations. Press or long press  $\leftarrow$  or  $\rightarrow$  to enter different numbers.

The interval time can be set as 1Sec ~ 60Min.

#### ● Set Duration

Press the function key EDIT (Menu) to set the duration time of continuous recording. Press or long press  $\leftarrow$  or  $\rightarrow$  to move the cursors to select edit locations. Press or long press  $\leftarrow$  or  $\rightarrow$  to enter different numbers. The duration time can be set as days, hours and minutes.



## ● Max Duration

Indicates the maximum time for continuous recording. After completing the settings, press the function key START (Menu) to start continuous recording as shown in Figure 13.

The character REC shows on the display and flashes with red dot. The relevant display information is shown in the following table.

Information	Description
Elapsed Time	Run time displayed in hours:minutes:seconds
Remaining Time	Time left displayed in hours:minutes:seconds
Samples	Total recording points for present recorded events
Start	Time and date started from recording period

To manually stop recording, press the function key STOP (Menu). When stop recording, return to the menu View Record to view the record events. See the relevant operations in the following menu View Record.



Figure 13

## 5) View Record

Press the function key(Menu) to view the information on record events as shown in Figure 14. The basic display information is in the following table.

Information	Description
Name	Name of record event
Interval	Interval time
Duration	Actual duration time after continuous recording stops
Samples	Total recording points for present record events
Maximum	Maximum value for present record data
Average	Average value for all data of present record
Minimum	Minimum value for present record data
REC	Position of present record incident and total number of record events
Start	Time and date started from recording period

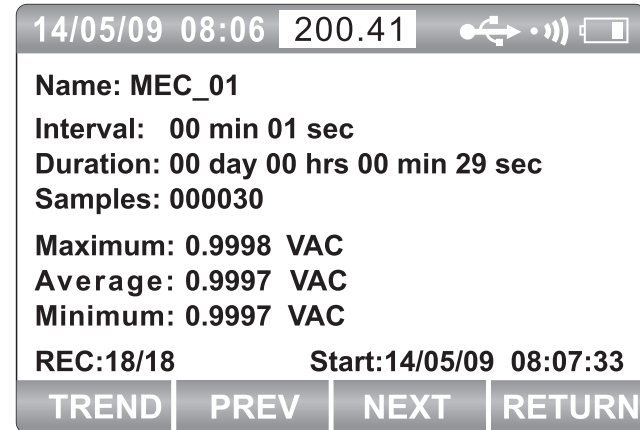

Figure 14



Press the function key PREV (Menu) to display basic information on the previous record. Press the function key NEXT (Menu) to display basic information on the next record. Press the function key RETURN (Menu) to return to the previous menu. Press the function key TREND (Menu) to view the trend chart of present record as shown in Figure 15. The display information of trend data is in the following table:

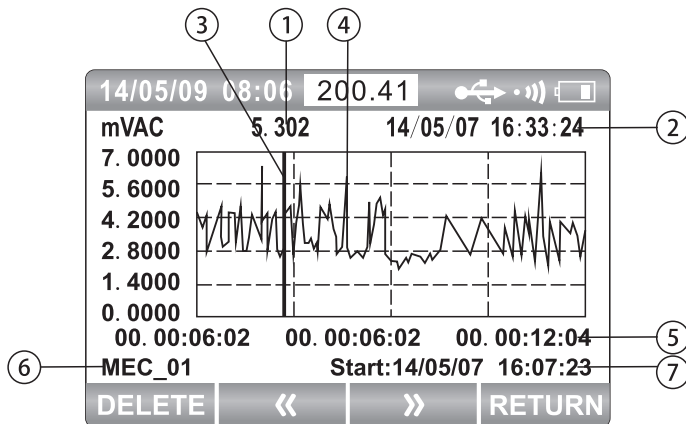

Figure 15

No.	Description
①	Measured value corresponding to cursor
②	Date and time for measurement corresponding to cursor
③	Cursor
④	Trend line
⑤	Time label of X-axis to display during elapsed time
⑥	Name of record event
⑦	Time and date started from recording period

View the trend chart. Press or long press the F2 key to move the cursor left. The cursor moves one data to the left for each pressing. Long pressing, the cursor speeds up to move left. Press or long press the F3 key to move the cursor right. The cursor moves one data to the right for each pressing. Long pressing, the cursor speeds up to move right. Press  $\odot$  or  $\ominus$  to scale the graph vertically. Press  $\triangleright$  or  $\triangleleft$  to scale the graph horizontally.

Press the F1 key to delete this record. Press the function key YES (Menu) to confirm the deletion. To cancel the deletion, press the function key NO (Menu).

### 6) Delete All Record

Press the function key DELETE (Menu) to delete all record events. Press the function key YES (Menu) to confirm. To cancel the operation, press the function key NO (Menu).

## 21. Communication

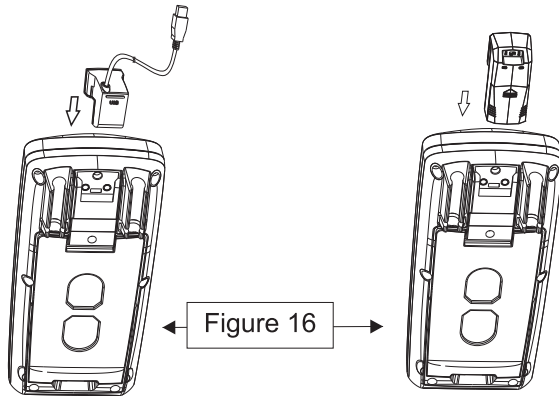

USB Communication    Bluetooth Communication (optional)

Turn on communication via settings (see detailed operations in the meter settings). The symbol  will appear in the upper left corner on the display as shown in Figure 16.

The meter carries on USB communication with USB cable (standard accessory) connecting to PC. The meter can use bluetooth module (optional) and mobile phone for bluetooth communication.

## X. Maintenance and Repair

### 1. General Maintenance and Repair

Regularly clean the meter case with damp cloth and mild detergent. Do not use abrasives, isopropyl alcohol or solvents. Dirt or moisture on the terminals can affect readings but also enable the warning function mistakenly due to mis-insertion. Clean the terminals according to the following steps:

- 1) Turn off the meter and remove all test leads.
- 2) Clean up the dirt on the terminals.
- 3) Soak a clean cotton swab in mild detergent and water. Clean each terminal with the cotton swab. Dry each terminal with canned compressed air to force water and detergent to flow out of the terminals.
- 4) In case of anything abnormal for the meter, stop using it and send it for repair.
- 5) When the meter needs to be verified or repaired, qualified service personnel or designated maintenance department are required to repair it.

### 2. Testing Fuse

As shown in Figure 17, the measurement of the meter is for resistance function. Insert a test lead into the terminal as shown in Figure 17 and contact the probe tip at the other end of test lead with the metal in the terminal of current input. If the message "Lead Error!" (connection error for test lead) appears, it shows that the probe tip is

inserted too deeply in the terminal of current input. Draw out the test lead a little until the error message disappears and 0L (overload) or resistance reading appears on the display. If the resistance reading for A terminal is less than  $0.50\Omega$ , it shows that the fuse F2 is normal. If the reading is 0L, you need to replace F2; If the resistance reading of  $\mu A$  m is less than  $1.2M\Omega$ , it shows that the fuse F1 is normal. If the reading is 0L, F1 needs to be replaced;

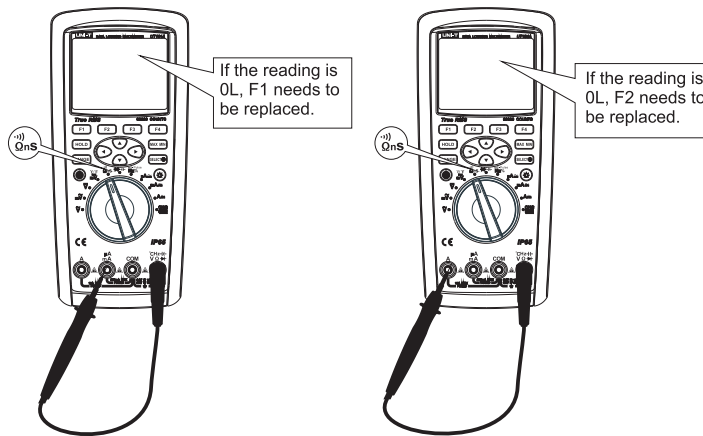

Figure 17

### 3. Replacing Fuse

Inspect or replace the meter fuse as shown in Figure 18 according to the following steps:

- 1) Turn off the meter and remove the test leads from the terminals.
- 2) Use a flat-head screwdriver to turn a counterclockwise semicycle for the screw on the battery cover then remove the battery cover.
- 3) Gently pry one end of the fuse and then remove the fuse from the clip.
- 4) The required fuse installed for mA or  $\mu A$  input terminal: 0.8A H 1000V Fuse Type 6X32mm(F1) The required fuse installed for A input terminal: 10A H 1000V Fuse Type 10X38 mm (F2)
- 5) Reinstall the battery cover and then turn the screw clockwise semicycle to tighten the battery cover.

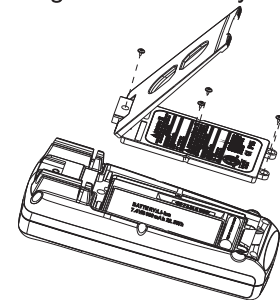



Figure 18

## 4. Battery charge

When the indicator of battery level in upper right corner is less than 5% of full capacity, the meter should be immediately charged, otherwise it will affect the measurement accuracy. As shown in Figure 19, set the rotary switch to , the string "Please plug in AC adapter!" on the display prompt you to insert a power adapter for charging. Connect the power connector to the four terminals in the meter, then insert the power adapter into the power connector. The character "Charging" on the display indicates it is in charging with a red light 5 % stepped in charging process. When the battery is fully charged, the red light is off and the charging process action stops.

### ⚠ Attention:

You must use the power adapter specified by the manufacturer.

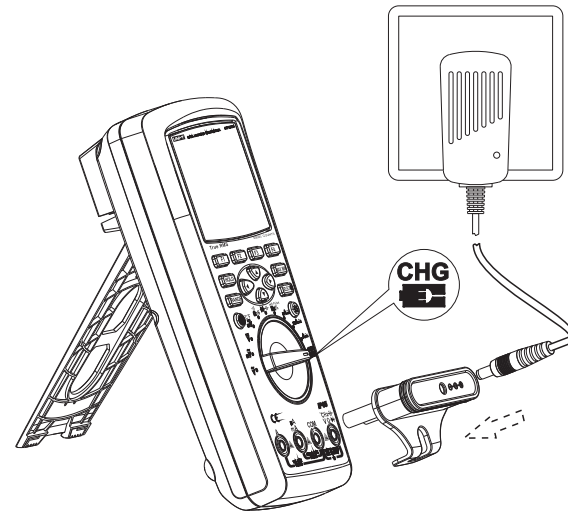

Figure 19

## UNI-T®

**UNI-TREND TECHNOLOGY (CHINA) CO., LTD.**

No6, Gong Ye Bei 1st Road,  
Songshan Lake National High-Tech Industrial  
Development Zone, Dongguan City,  
Guangdong Province, China  
Tel: (86-769) 8572 3888  
<http://www.uni-trend.com>